

Mercedes-Benz Wallbox Home



Operating Manual

Mercedes-Benz
The best or nothing.



Important addresses

Contact

Daimler AG
Mercedesstraße 137
70327 Stuttgart, Germany

For technical issues, please contact your local Mercedes-Benz technical support.

This manual, in its entirety or in parts, must not be reproduced, stored electronically or otherwise transmitted electronically, electrically, mechanically, optically, chemically, by photocopy or as an audio recording without express written permission.

Contents

Important addresses	ii	Operational malfunctions and solutions	9
Important information	1	Taking the product out of and back into operation	9
About this manual	1	Frequently asked questions	10
Safety notices in this manual	1	Appendix	12
Safety notices on the device	1	Technical specifications	12
General safety information	2	Scale drawings and dimensions	13
General product information	2	Standards & guidelines	13
User information	3	CE certification and compliance declaration	14
Introduction	4	Maintenance	14
Introducing the product	4	Cleaning and care	15
Unpacking and components included	4	Trademarks	15
Identifying your model variant	5	Intellectual Property & Copyright	16
Charging procedure	6	Disposal advice	16
Charging procedure using the Mercedes-Benz Wallbox Home	6		
Resolving errors	8		
Error messages during the charging procedure	8		

Important information

About this manual

This manual documents the steps and options necessary for setup, use and taking out of operation of your Mercedes-Benz Wallbox Home. Certain sections of this manual are specially formatted for quick and easy reference.

Descriptions listing equally valid options (as is the case here) are indicated by bullet points.

- Descriptions that describe performing a function are shown in the form of numerical lists indicating the order of the individual working steps.

Please make sure you read this manual, as it contains important information for use of the Wallbox with your Mercedes-Benz vehicle. Please especially follow all operational and safety notices that are printed in this manual.

Keep this manual in a safe place for future reference. In case the Wallbox is operated by several users, the contents of this manual, and the safety notices in particular, must always be passed on to each individual user or made available to them.

All dimensions in this manual are in millimeters. Where necessary, the scale is indicated for different illustrations.

Please note that all technical details, specifications and design characteristics of the product may be changed without prior notice.

Safety notices in this manual

In particular, the warnings and safety measures in this manual that are marked as follows must be adhered to. The symbols carry the following meanings:

DANGER!

Sections marked with this symbol draw attention to electrical voltages that represent a danger to life and limb: Actions contrary to these safety notices may lead to severe or fatal injury. Actions marked with this symbol must not be carried out under any circumstances.

CAUTION!

Sections marked with this symbol draw attention to further hazards that may lead to damage to the Wallbox itself or to other electric devices. Actions marked with this symbol must be carried out with special care.

PLEASE NOTE!

Sections marked with this symbol draw attention to further important information and special features that are necessary for the reliable operation of the device. Actions marked with this symbol should be carried out as required.

Safety notices on the device

Further operational and safety notices are provided on the outside of the housing and on the electronic components cover inside the Wallbox. These symbols carry the following meanings:

WARNING!

Please ensure that you first read the operating manual included with the Mercedes-Benz Wallbox Home, especially before you remove the housing cover of your Wallbox.



WARNING!

After opening the housing, dangerous voltages may be present on the inside of the Wallbox as well as on components you are able to touch.

General safety information

Please pay attention to the following points:

- Read this manual carefully.
- Heed all warnings.
- Follow all instructions.
- The Wallbox must be installed, connected and approved for operation according to local rules and regulations by a qualified specialist electrical contractor.
- Please ensure that minimum clearances of 50 cm are kept on all sides of the Wallbox after installation.
- Never remove the electronic components cover inside the Mercedes-Benz Wallbox Home housing cover: Cleaning or maintenance of components behind this cover are not necessary, and must under no circumstances be performed by the user.
- The Mercedes-Benz Wallbox must only be operated with the housing cover closed and locked: Before charging, ensure that the housing cover is properly locked.
- Only use accessories intended and sold for the device by Mercedes-Benz.
- Do not operate this Wallbox in close vicinity to running water or water jets: However, the Mercedes-Benz Wallbox Home is sufficiently protected against water splashes and sprays according to the respective degree of protection.
- The Mercedes-Benz Wallbox Home must not be operated in areas subject to flooding.
- The Mercedes-Benz Wallbox Home must not be operated in explosive atmosphere areas (EX areas).
- The Mercedes-Benz Wallbox Home must not be covered with stickers or other objects or materials to ensure sufficient air circulation at all times.
- No liquids, objects or receptacles containing liquids must be placed on the housing.
- Please note that operating a radio transmitter in the immediate vicinity (< 20 cm) of the Wallbox may lead to malfunctions and should therefore be avoided.
- This device is not intended to be used by persons with limited physical, sensory or mental abilities (including children) and/or who lack knowledge, unless they are supervised by someone responsible for their safety or have received instructions from such a person on how to use the device.
- Children must be supervised so that they do not play with the device.
- Please note that the Mercedes-Benz Wallbox Home may be installed and operated at elevations of max. 2,000 meters AMSL (above mean sea level).

General product information

This Mercedes-Benz Wallbox Home represents the current state of technology and complies with all current technical safety requirements, guidelines and standards. The safety information provided in this manual serves to ensure the proper and safe operation of the device. Disregard of or actions contrary to the safety information and instructions contained in this manual may lead to electric shock, fire and/or severe injury. Malfunctions affecting the safety of persons, connected electric devices or the device itself must be resolved by a specialist electrical contractor.

Should a malfunction occur with the Wallbox, please always contact the company that carried out the installation first. If the malfunction can still not be resolved, please contact your local Mercedes-Benz technical support.

Always contact Mercedes-Benz technical support if:

- the housing has been damaged mechanically,
- the housing cover has been removed or can no longer be closed or locked,
- it becomes obvious that sufficient protection against water and/or foreign objects entering the device is no longer possible,
- there is functional or visible damage to the fixed charging cable,
- or the Wallbox does not function properly or has been otherwise damaged.

 **DANGER!**

Should you detect damage to the housing or charging cable, you must take the Wallbox out of operation immediately via the upstream miniature circuit breaker in your domestic power distribution and the internal residual current circuit breaker: No further use of the Wallbox is permitted in this case! Please contact your local Mercedes-Benz technical support!

User information

To operate your Wallbox, please note these instructions:

- The device must always be connected to the protective earth conductor of your electricity supply. The protective earth connection will be made and checked by the installing contractor. After installation, only qualified specialist electrical contractors may make changes.
- The Wallbox should not be operated in areas of high pedestrian traffic. Installation along thoroughfares and marked escape routes should be especially avoided.
- When there is no charging procedure under way, the charging plug should always be attached to the storage holder on the side of the Wallbox to avoid trip hazards.
- Please note that the fixed charging cable of the Mercedes-Benz Wallbox Home must not be extended with connectors, adapter cables or in any other way during operation.
- Ensure that the rated voltage and rated current of the device comply with the parameters of your local electricity grid and that the rated output is not exceeded during the charging procedure.
- At all times comply with local safety regulations for the country in which you operate the Wallbox.
- To disconnect the Wallbox completely from the electricity grid, the power supply must always be interrupted using the upstream miniature circuit breaker in the domestic power distribution and the internal residual current circuit breaker.
- Never operate the Wallbox in a confined space. In particular, you must ensure that the vehicle can be parked at a suitable distance from the Wallbox and connected without any strain on the charging cable.
- A parking spot for the vehicle must be planned for in the area in front of the Wallbox. The distance between vehicle and Wallbox should be at least 50 cm and no more than ca. 5 m.
- Make sure that the Wallbox housing cover is always closed and locked when in use. Keep the key for unlocking the cover in a place that is only accessible to authorized users.
- Under no circumstances remove the internal electronic components cover located behind the housing cover of the Wallbox.
- You must not under any circumstances make any changes to the housing or the internal wiring of the Wallbox: Any disregard of this instruction represents a safety risk, fundamentally breaches the guarantee provisions and may void the warranty with immediate effect.
- Only have qualified, specialist personnel install or uninstall the device. No parts to be maintained by the user are located inside the device.

Introduction

Thank you for choosing this Wallbox to charge your Mercedes-Benz electric vehicle. With the Mercedes-Benz Wallbox Home, you have decided on an innovative and future proof solution.

The Mercedes-Benz Wallbox Home combines progressive and pleasing design with intuitive functionality and is engineered for domestic as well as semi-public applications.

Mercedes-Benz Wallboxes are manufactured in Germany and comply with all regulations and norms for the charging of electric vehicles applicable throughout Europe according to IEC 61851-1, Mode 3: Please refer also to the section on “Standards & guidelines” on page 13.

Introducing the product

Your Mercedes-Benz Wallbox Home allows you to comfortably and safely charge electric vehicles according to IEC 61851-1, Mode 3 and is designed for the shortest possible charging times.



We place the highest value on user safety in all our products. For this purpose, your Wallbox features an internal Type A residual current circuit breaker and integrated DC fault current detection which, in combination with the protective measures of your domestic power supply and of your electric vehicle effectively protects from short circuit, electric shock and other operational hazards.

The Wallbox is especially easy to operate during everyday use: A multi-colored LED display on the front of the Wallbox allows you to check the current operating status at any time. Should a malfunction occur, you can identify the cause by the specific error code displayed by the multi-colored LED without having to open the housing of the Wallbox. After being taken into operation by a specialist contractor, the Mercedes-Benz Wallbox Home is ready for charging at any time, while each charging process must be separately authorized via the integrated key switch.

A common characteristic of all Wallboxes is the space-saving housing, which effectively protects the internal electric circuits against environmental influences and unauthorized access. In principle, all model variants of the Wallbox must be installed and taken into operation by a specialist electrical contractor. Please contact your local Mercedes-Benz partner with any queries you may have.

Unpacking and components included

Your Mercedes-Benz Wallbox Home is delivered in an extremely sturdy carton, including a range of accessory components required for proper operation. Therefore, please check immediately after unpacking whether the following components are included:

	Component	Quantity	Description
	Wall box	1	Charging station consisting of housing base with integrated electronic unit, internal electronic components cover and housing cover
	Quick start guide	1	Quick start guide including safety notices in printed form
	Installation kit	1	Set of fixings for wall mounting, consisting of 2 x 4 chipboard screws as well as matching wall plugs, keys for key switch (2 pcs.), keys for locking the housing cover (2 pcs.), drilling template

Should one or more components be missing after unpacking, please contact your local Mercedes-Benz distributor immediately.



PLEASE NOTE!

The carton in which the Mercedes-Benz Wallbox Home is delivered offers optimal protection against external influences during transport and storage. If possible, keep this carton and use it to pack the Mercedes-Benz Wallbox Home, should you need to send it to the manufacturer or otherwise transport it because of a malfunction or similar.

Identifying your model variant

The Mercedes-Benz Wallbox is available in a range of model variants that are mechanically and electrically tailored to different application profiles. A product sticker with the specific Mercedes-Benz product identification number is located on the underside of the Wallbox. Please check the product sticker to ensure that the model variant you have installed is the one described in this manual.

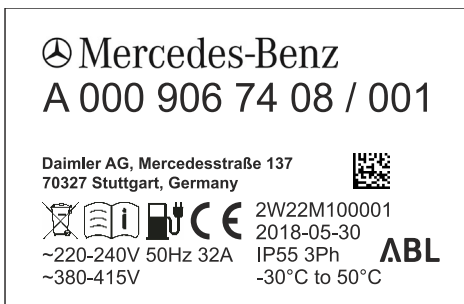

For identification, the model code (A 000 906 XX XX) as well as the power supply ratings (voltage, frequency, current) indicated below it are especially relevant.

The following Wallboxes are described in this manual:

Model	Power supply	Variant
A0009067408	230 / 400 V 50 Hz 1 or 3 x 32 A	Fixed charging cable according to IEC 62196-2 Type 2, ca. 6 m; charging output 22 kW
A0009067508	230 V 50 Hz 1 x 32 A	Fixed charging cable according to IEC 62196-2 Type 2, ca. 6 m; charging output 7.2 kW



CAUTION!

The information and technical specifications contained in this manual relate exclusively to the model variants listed in this manual and must not be transferred to other Wallbox models: These variants come with their own manuals where necessary.

Charging procedure

The mechanical and electrical installation of the Mercedes-Benz Wallbox Home model variants described in this manual must always be carried out by qualified specialist personnel: The preparation of and electrical connection to your domestic power supply in particular must be carried out by a specialist electrical contractor, and subsequently inspected and approved as part of the process of taking the device into operation. Please contact a specialist electrical contractor or your local Mercedes-Benz partner, who will be pleased to assist you with any questions regarding the installation and operation of your Wallbox.

The installation itself is described in a separate installation manual. That manual contains important information regarding mechanical and electrical installation as well as regarding the subsequent functional inspection, approval and taking into operation of the Wallbox. It is advisable that you are present when the device is taken into operation for the first time by a specialist electrical contractor to ensure that you are able to easily carry out charging procedures with your Mercedes-Benz Wallbox Home.

The current operating status of the Wallbox is indicated by a multi-colored LED display in the lower part of the housing cover. Unless a malfunction is occurring, during operation the LED may ...



... glow green or yellow



... cyclically pulsate green or blue



You can find further information about operating states on the following pages. You can find further information about error states in chapter "Resolving errors" on page 8.

Charging procedure using the Mercedes-Benz Wallbox Home

The Wallbox is engineered for the fastest possible charging procedure of your Mercedes-Benz vehicle according to IEC 61851-1, Mode 3. Actual charging time depends on the vehicle to be charged and its remaining level of charge.

The Mercedes-Benz Wallbox Home is available in model variants with fixed Type 2 charging cable and different charging outputs. When not in use, the charging plug is secured in the charging plug storage holder on the right side of the Wallbox housing and is only removed for the charging procedure.

CAUTION!

The Mercedes-Benz Wallbox Home must only be operated with the housing cover locked: Before charging, ensure that the housing cover is installed and locked using the key provided.

Please follow these steps to charge your Mercedes-Benz vehicle using the Wallbox:

1. Park your vehicle so that the vehicle charging socket can be easily reached with the charging plug of the charging cable:
The charging cable must not be stretched tight or strained during the charging procedure.
2. Open the vehicle charging socket as described in the vehicle's operating manual.
3. Check the LED display at the front of the Wallbox: When the Wallbox is ready for operation, the LED located in the lower part of the housing cover will pulsate blue.
The vehicle may now be connected.



4. Remove the charging plug from its storage holder and insert it completely into the vehicle's charging socket: Communication with the vehicle is being checked and the Wallbox is awaiting authorization by the operator. In this state, the LED will glow yellow.



5. Should the key switch on the right hand side of the housing be in the horizontal position, you must turn it to the vertical position in order to authorize the charging procedure.



Key switch in horizontal position:
The next charging procedure is blocked.

As long as the key switch remains in the vertical position, you can conduct further charging procedures at any time and without separate authorization.



Key switch in vertical position:
Charging procedure unblocked.

i PLEASE NOTE!

Unlocking is only required to start the charging procedure: The key switch may be returned to the horizontal position immediately afterwards, and this will not interrupt the current charging procedure. However, after severing the connection with the vehicle, the next charging procedure is then again blocked by the Wallbox.

6. After authorization of the charging procedure via the key switch, the Wallbox will wait for the charging procedure to be initiated by the vehicle. In this state, the LED will glow green.



7. When the vehicle requests the charging procedure to be initiated and it is started by the Wallbox, the LED will pulsate green during the charging procedure.



If required, the charging procedure can be interrupted manually at the vehicle (see operating manual of the vehicle to be charged).

8. When the charging procedure is paused or completed, the LED will continuously glow green again.



9. After the charging procedure is completed, disconnect the charging plug from the vehicle socket and secure it in the charging plug storage holder on the right hand side of the Wallbox.



The LED will now pulsate blue again, indicating that the Wallbox is ready for the next charging procedure.

i PLEASE NOTE!











Unless there is a malfunction, the charging procedure is only ever terminated by the vehicle or the user. When the LED glows green, it indicates – on the basis of communication with the vehicle – that the charging procedure has been either paused or completed: Distinguishing these two operating states is only possible by checking the displays inside the vehicle. Should the vehicle, even after a sufficiently long charging procedure, not be fully charged, please contact your local Mercedes-Benz technical support.

Resolving errors

Your Mercedes-Benz Wallbox Home is engineered for maximum operational safety and the highest possible charging reliability. Should a malfunction occur in practice, this is indicated by the multi-colored LED display on the lower part of the housing cover. The following chapter describes how you recognize error codes and which measures you must take to resolve them.

Error messages during the charging procedure

In some circumstances, malfunctions and disruptions of the charging procedure may occur that prevent the proper charging of the vehicle according to IEC 61851-1. The Mercedes-Benz Wallbox Home independently detects possible internal errors as well as errors on the part of the vehicle and shows them via the LED display. To represent different error states, the multicolor LED will flash in a specific, repeating pattern. The following error states are displayed:

LED display (cyclical)	Error description
	If the LED flashes red once and then green four times, the Wallbox has detected an error and will automatically trigger its internal RCCB after 20 seconds. Switch the power supply of the Wallbox back on via the RCCB in order to reset the device. If this error repeats or persists, an internal malfunction has occurred and the Wallbox must be replaced. Take the Wallbox out of operation (see page 9) and contact your local Mercedes-Benz technical support.
	If the LED flashes red once followed by blue and green, the Wallbox has detected an internal error. Switch off the power supply of the Wallbox via the upstream miniature circuit breaker in your domestic power distribution and then back on again in order to reset the device. If this error repeats or persists, an internal malfunction has occurred and the Wallbox must be replaced. Take the Wallbox out of operation (see page 9) and contact your local Mercedes-Benz technical support.
     	If the LED flashes red once, followed by blue, green or yellow, the Wallbox has detected an error. The Wallbox will automatically re-initiate the charging procedure in order to reset itself. If the error repeats or persists, an analysis must be carried out to determine whether a malfunction has occurred in the vehicle or in the Wallbox. Take the Wallbox out of operation (see page 9) and contact your local Mercedes-Benz technical support.
 	If the LED pulsates on green and flashes on red or blue, the wallbox is reducing the charging current. Charging operations can continue with reduced charging output. If the error repeats or persists, an analysis must be carried out to determine its exact cause. Take the Wallbox out of operation (see page 9) and contact your local Mercedes-Benz technical support.

i PLEASE NOTE!

You can find a comprehensive list of all error messages in the installation manual for your Wallbox.

For most error states, the Wallbox automatically reinitiates the charging procedure, checking communications with the vehicle. However, in practice, it is advisable to manually restart the Wallbox by switching the power supply off and back on via

the upstream miniature circuit breaker in the domestic power distribution as not all errors can be resolved by the automatic restart of the Wallbox.

⚠ CAUTION!

If the Wallbox continues to show error messages during charging, please always contact your local Mercedes-Benz technical support. It is possible that your vehicle must be repaired or the Wallbox needs to be replaced before the vehicle can be charged again using the Wallbox.

Operational malfunctions and solutions

For secure operation, the Mercedes-Benz Wallbox Home must be protected during operation by an upstream miniature circuit breaker in the domestic power distribution and the internal residual current circuit breaker. To take suitable measures and restore operation in case of malfunction, you must first clearly identify the type of error. The following errors may occur:

Type of error	Possible cause	Suggested solution
The LED is not functioning.	The Wallbox does not have a power supply.	The power supply is interrupted: Check the upstream miniature circuit breaker in the domestic power distribution and the internal residual current circuit breaker (see section "Maintenance" on page 14) and switch them back on if required. If the error repeats or occurs permanently, contact your local Mercedes-Benz technical support.
	An internal fault has occurred in the Wallbox.	The Wallbox must be replaced. In this case, please contact your local Mercedes-Benz technical support.
The electric vehicle is not recognized.	The charging plug is not properly plugged into the vehicle.	Remove the charging plug from the vehicle and plug it back in: If the error continues to occur, please contact your local Mercedes-Benz technical support.
The LED shows an error code.	The Mercedes-Benz Wallbox Home detects a malfunction.	Restart the Wallbox by switching off the power supply via the upstream miniature circuit breaker in your domestic power distribution and then back on again. If the error repeats or occurs permanently, take the Wallbox out of operation (see below) and contact your local Mercedes-Benz technical support.

i PLEASE NOTE!

Should the power supply for the Wallbox be faulty, contact the specialist electrical contractor who installed the device.

Taking the product out of and back into operation

If required, you can take your Mercedes-Benz Wallbox Home out of operation. Proceed as follows:

1. Switch off the upstream miniature circuit breaker in your domestic power distribution (connection to the electricity grid is interrupted).
2. Unlock the housing cover of the Wallbox ① using the housing cover key and remove it.
3. Open the access flap in the electronic components cover ② and flick the pivot lever of the residual current circuit breaker ③ to the 0 position.
4. Close the access flap in the electronic components cover ②, replace the housing cover of the Wallbox ① and lock it.

Now, the Mercedes-Benz Wallbox Home can no longer be used for charging.

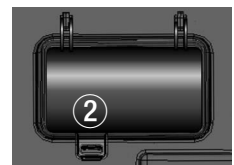

To take the Wallbox back into operation at a later time, please proceed as follows:

1. Remove the housing cover of the Wallbox ①.
2. Open the access flap in the electronic components cover ② and flick the pivot lever of the residual current circuit breaker ③ to the I position (connection with the electricity grid is established).
3. Close the access flap in the electronic components cover ②, replace the housing cover of the Wallbox ① and lock it.
4. Switch on the upstream miniature circuit breaker in your domestic power distribution.



When the Wallbox is reconnected to the electricity grid, it will initiate the start-up procedure: This includes a test of the internal electronic components to ensure correct functioning.

The internal check routine is indicated by the LED display on the front of the Mercedes-Benz Wallbox Home as follows.

LED display	Description
	The LED flashes white once ...
	... and then pulsates blue.

The vehicle can now be connected for charging.

Frequently asked questions

A few frequently asked questions regarding installation and operation of your Mercedes-Benz Wallbox Home are listed here. Please always read this section first before you contact your local technical support: Your question may already be answered here.

Can I install the Mercedes-Benz Wallbox Home myself?

- No, electrical installation of the Mercedes-Benz Wallbox Home must always be carried out by a qualified specialist electrical contractor. Only then can electrically safe operation be guaranteed.
- Installing the Mercedes-Benz Wallbox Home yourself can lead to a breach of warranty provisions and voids the warranty protection for operating the Wallbox.

How must the Mercedes-Benz Wallbox Home be protected electrically?

- All phases of the Mercedes-Benz Wallbox Home must be protected in the domestic power distribution. Please always follow all local regulations for operating electrical devices.

Can the Mercedes-Benz Wallbox Home A0009067408 also be operated on a single phase power supply?

- Yes, in principle all model variants of the Mercedes-Benz Wallbox Home can be operated on a single phase power supply.

The Mercedes-Benz Wallbox Home is out of order (no LED display). How do I investigate the cause?

- If no vehicle is connected to the Wallbox, the multi-colored LED display of the Wallbox must pulsate blue. Should this not be the case, please check the following:
 1. The upstream miniature circuit breaker in your domestic power distribution
 2. The internal residual current circuit breakerShould these protection devices not show any obvious sign of malfunction, please contact your local Mercedes-Benz technical support.

The charging output of the Mercedes-Benz Wallbox Home is lower than expected. What may be the cause?

- Please check first whether a limit to the charging output has been set in the vehicle (see the operating manual of the vehicle to be charged).
- In some error scenarios, the internal safety circuits of the Mercedes-Benz Wallbox Home are triggered so that the current is being limited: In this case, the multi-colored LED display will pulsate green and flash red once. However, charging operations can continue. Should the internal safety features be activated repeatedly or permanently, please take the Wallbox out of operation (see page 9) and contact your local Mercedes-Benz technical support.
- Have the maximum charge current setting of the Wallbox checked and adjusted if necessary by a qualified specialist electrical contractor (see the section 'Setup and test mode') in the comprehensive installation manual for the Mercedes-Benz Wallbox Home).

Where can I order spare parts for the Wallbox?

- Should you need spare parts for your Wallbox, please contact your local Mercedes-Benz technical support.

The key for opening the housing cover or for unblocking the charging procedure has been lost. Can I order a replacement key?

- Two keys for unlocking the housing cover are included with the Mercedes-Benz Wallbox Home. Two keys for the key switch on the side of the box, which is used to unblock the charging procedure, are also included: If both keys to the key switch have been lost and the key switch on the right hand side of the housing is in the horizontal position, the Wallbox is blocked for charging operations and no further charging procedures are possible. In case of loss of the housing cover key (Order No.: E290400) or key switch key (Order No.: E390401) you can order replacements from:

› eMobility Support

- › Phone +49 (0) 9123 188-600
- › Email emobility.support@abl.de
- You will need the serial number of your Wallbox for ordering replacement keys for the key switch. You can find the serial number on the product label on the underside of the housing.

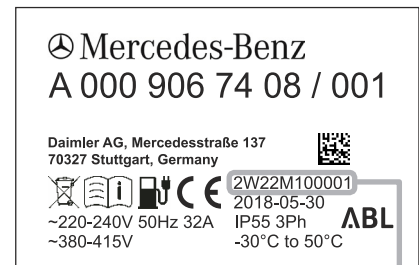

Wallbox serial number

Appendix

Technical specifications

Model variant	A0009067408	A0009067508
Compliance	IEC 61851-1 / 61439-7	
Power supply	for supply cable sizes of up to 5 x 16 mm ²	for supply cable sizes of up to 3 x 16 mm ²
Rated voltage	230 / 400 V	230 V
Rated current	32 A, single or 3-phase	32 A, single phase
Rated frequency	50 Hz	
Max. output	22 kW	7.2 kW
Charging connection	Fixed charging cable with charging plug according to IEC 62196-2 Type 2, ca. 6 m	
Circuit-protection devices	Type A 30 mA RCCB and DC-RCM, I _{Δn d.c.} electronic DC fault current detection ≥ 6 mA	
Control / Customization	Internal RS485 interface (interface for external load management, no access for users/installation technicians)	
Upstream fuse	C characteristic MCB, rated current according to power supply and Wallbox setting but no more than 32 A	
Factory setting for maximum charging current	16 A	32 A
PE system	TN-S	
Operating temperature	-30 to 50°C	
Storage temperature	-30 to 85°C	
Relative humidity	5 to 95% (no condensation)	
Class of protection	I	
Overvoltage category	III	
Degree of pollution	3	
Rated insulation voltage (U _i)	4 kV	
Rated impulse voltage (U _{imp})	4 kV	
Rated peak withstand current (I _{pk})	6 kA	
Rated short-time withstand current (I _{cw})	5 kA	
Rated conditional short-circuit current (I _{cc})	6/10 kA (C tripping characteristic)	
Rated diversity factor (RDF)	1.0	
Degree of protection (housing)	IP 55	
Impact strength	IK08	
Dimensions (housing)	438 x 328 x 170 mm (H x W x D)	
Maximum elevation	≤ 2,000 m AMSL (above mean sea level)	
Weight per unit (net)	ca. 8.5 kg	
Weight per unit (gross)	ca. 10 kg	

Scale drawings and dimensions

The Mercedes-Benz Wallbox Home is delivered fully assembled and checked. All dimensions are indicated in the scale drawings below.

Wall box with fixed charging cable (pictured: A0009067408 and A0009067508)

Plan and elevation (all dimensions in mm)

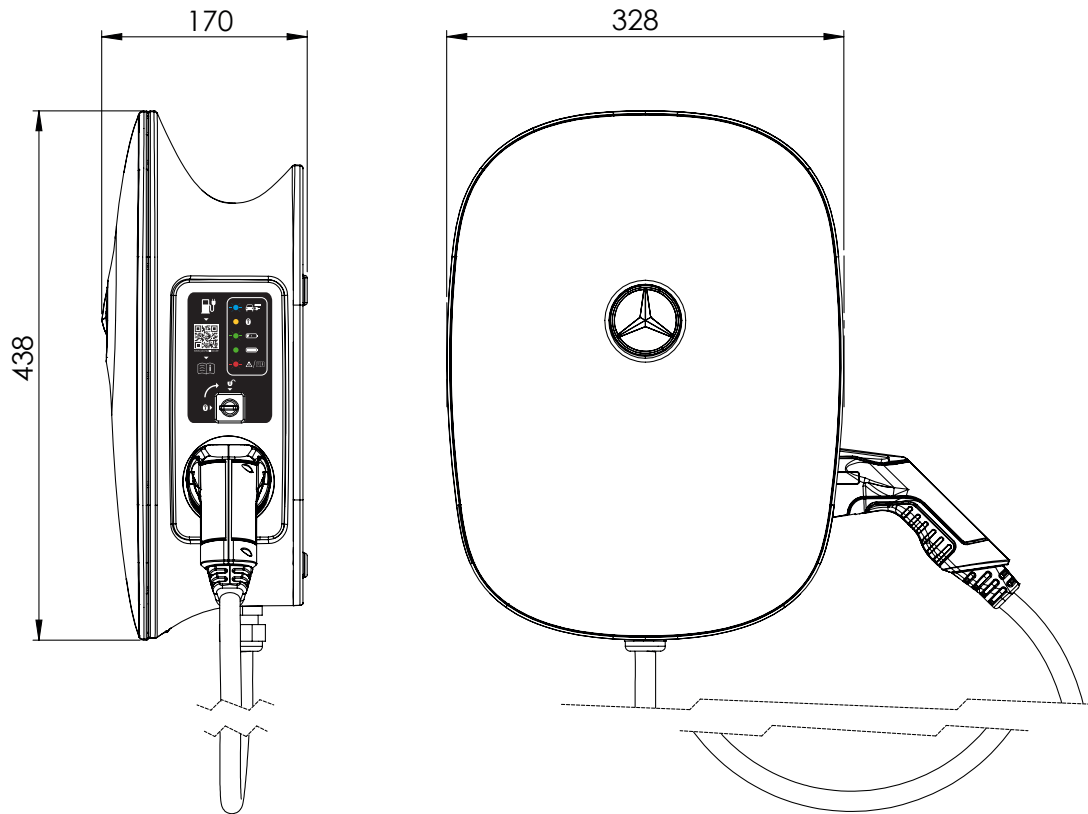

Standards & guidelines

The Mercedes-Benz Wallbox Home complies with the following standards and protection ratings:

General guidelines and laws

Guideline	Explanation
2014/35/EU	Low voltage directive
2014/30/EU	EMC Guideline
2011/65/EU	RoHS 2 guideline
2012/19/EU	WEEE Guideline
ElektroG	Electrical and Electronic Device Statute

Device safety standards

Standard	Explanation
IEC 61851-1: 2017 Ed. 3.0	Conductive charging systems for electric vehicles – Part 1: General requirements
IEC/TS 61439-7:2014	Part 7: Switching device combinations for specific applications such as marinas, campgrounds, market squares, charging stations for electric vehicles
IEC 61000-6-2:2016	Electromagnetic compatibility (EMC) – Part 6-2: Generic standards – immunity standard for industrial environments
IEC 61000-6-3:2006+AMD1:2010	Electromagnetic compatibility (EMC) – Part 6-3: Generic standards – Emission standard for residential, commercial and light-industrial environments
IEC 61000-6-7:2014	Electromagnetic compatibility (EMC) – Part 6-7: Generic standards – Immunity requirements for equipment intended to perform functions in a safety-related system (functional safety) in industrial locations
IEC 61851-21-2: 2018 Ed. 1.0	Conductive charging systems for electric vehicles – Part 21-2: EMC requirements for off board electric vehicle charging systems

Classes of protection & degrees of protection

Class of protection / degree of protection	Explanation
	The device complies with IEC protection class 1.
IP 55	Degree of protection: complete protection against touch, protection against dust in harmful quantities and against light water jets from any angle (DIN EN 60529: 2014-09)

CE certification and compliance declaration

 The Mercedes-Benz Wallbox Home carries the CE mark. The associated declaration of compliance is available for download in electronic format at www.yourwallbox.de/downloads/documents/Declaration_of_Conformity_Home_Advanced.pdf.

Maintenance

After installation, your Mercedes-Benz Wallbox Home is mostly maintenance-free. However, because the Wallbox processes high electrical voltages internally, it is recommended to conduct a visual inspection of the housing and check the externally accessible components and accessories at certain intervals (e.g. biannually).

DANGER!

Never remove the internal electronic components cover of the Mercedes-Benz Wallbox Home: Cleaning or maintenance of components behind this cover is not necessary, and must under no circumstances be performed by the user.

- Conduct a visual inspection of the housing surfaces as well as the charging cable holder and check for damage.
- Conduct a visual inspection of the charging cable and ensure that cable and charging plug do not show any visible damage or deformation.

Should you find any obvious damage during the above-mentioned checks, please contact your local Mercedes-Benz technical support. Have all damage repaired before continuing to operate the Wallbox. Until then, take the Wallbox out of operation as described in section “Taking the product out of and back into operation” on page 9.

- The Mercedes-Benz Wallbox Home does not have a dedicated ON/OFF switch: If you want to take the Wallbox out of operation, you must always switch the upstream domestic circuit breaker and the internal residual current circuit breaker to the **0** (OFF) position.

The proper functioning of the internal residual current circuit breaker must be checked biannually to ensure it functions correctly during operation. Proceed as follows to test the residual current circuit breaker:

1. Remove the housing cover of the Wallbox ① using the key provided.
2. Open the access flap ②.
3. Locate the button engraved **T** or marked **Test** on the internal residual current circuit breaker ③:
4. Press the button: The residual current circuit breaker should now trip and flick its pivot lever to the central position (connection to the power supply is interrupted).
5. Now flip the pivot lever of the residual current circuit breaker ③ to the **0** position and then back to the **I** position.
6. Close the access flap ②, replace the housing cover ① and lock it using the key.

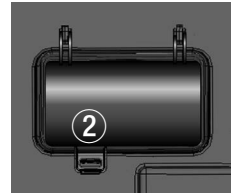

⚠ DANGER!

Should the residual current circuit breaker not trip during testing (pivot lever in the central position), you must not continue to operate the Wallbox under any circumstances! Please take the Wallbox out of operation by switching off the upstream miniature circuit breaker in the domestic power distribution and the internal residual current circuit breaker to the (**0** OFF position) and contact Mercedes-Benz technical support.

Cleaning and care

- The surface of the Mercedes-Benz Wallbox Home can be cleaned with a dry cloth.
- For heavier soiling, use a mild detergent solution on a damp, well-wrung cloth.
- Do not use aggressive chemical cleaning agents, glass cleaners, waxes or solvents (such as cleaning fluid or paint thinner) because they can dull the surfaces and displays on the device.
- Do not use abrasive cleaning agents or sponges as these can scratch the surface of the housing cover.

⚠ DANGER!

The Mercedes-Benz Wallbox Home must under no circumstances be cleaned with a pressure cleaner or any similar device where liquids or steam could enter the openings in the housing because of high pressure.

Trademarks

All trademarks mentioned in this manual, including those that may be protected by third parties are, without restriction, subject to the regulations of the respectively applicable trademark law and the property rights of the respective registered owners.

All trademarks, trading names or company names marked here as such are or may be trademarks or registered trademarks of their respective owners. All rights not explicitly granted here are reserved.

The absence of explicit identification of trademarks used in this manual must not lead to the conclusion that a name is free from the rights of third parties.

Intellectual Property & Copyright

Copyright © 2018

Version 1.0, MB-UM_Home-2018-07-09

All rights reserved.

Any information in this manual may be changed without prior notice and does not represent any obligation on the part of the manufacturer.

Illustrations in this manual may show designs different from the delivered product and do not represent any obligation on the part of the manufacturer.

The manufacturer does not take responsibility for any losses and/or damages that occur because of the data or possible misinformation contained in this manual.

This manual, in its entirety or in parts, must not be reproduced, stored electronically or otherwise transmitted electronically, electrically, mechanically, optically, chemically, by photocopy or as an audio recording without the written permission of the manufacturer.

Disposal advice



For the preservation and protection of the environment, the prevention of pollution and in order to improve the recycling of resources, the European Commission has issued a guideline (WEEE-Guideline 2012/19/EC and EAG-VO) according to which electrical and electronic devices are taken back by the manufacturer in order to have them properly disposed of or recycled.

Therefore, devices marked with this symbol may not be disposed of as part of unsorted domestic waste inside the European Union: Please enquire with your local authorities regarding proper disposal.

The materials are recyclable as marked. By re-using, recycling or through other forms of processing obsolete devices, you make an important contribution to environmental protection.

The manufacturer may have made minor technical modifications to the product after publication of this operating manual. This may also have led to minor discrepancies in the appearance of the product. Any color differences are a result of the printing process.



Mercedes-Benz

Daimler AG, Mercedesstr. 137, 70327 Stuttgart, Germany